



Operating Instructions



Let's make things better.



PHILIPS



TABLE OF CONTENTS

Introduction

Safety Information/Useful Tips	3
Before Calling Service	4

Basic Installation/Functions

Hooking Up Your TV (Basic Connection)	5
Use/Care of remote Control	5
Connecting the Audio/Video Sockets (Playback)	6
Connecting the Audio/Video Sockets (Recording)	8
Functions of Remote Control	9
Functions of TV Controls	11

TV Installation

Selecting the Menu Language.....	12
Automatic Tuning of Channels	13
Manual Tuning of Channels	14
Selecting the Colour/Sound System	16
Fine Tuning Of Channels	17
Sorting of Channels.....	18
Editing of Channels.....	19
Naming of Channels.....	20

Features

Adjusting the TV Picture	21
Adjusting the TV Sound	22
Activating the Timer.....	23
Activating the Child Lock.....	25
Using the Screen Format	29
Smart Picture Control	30
Smart Sound Control.....	31
Personal Zapping	32
Auto Picture Booster	33
Rotation	34
Using the Teletext.....	35

General

Specifications.....	37
---------------------	----



Recycling Directive – To minimise harm to the environment, the batteries supplied with the TV set do not contain mercury or nickel cadmium. If possible, when disposing of batteries, use recycling means available to you. Your TV set uses materials which are reusable or which can be recycled. To minimise the amount of waste in the environment, specialist companies recover used sets for dismantling and collection of reusable materials (contact your dealer).



SAFETY INFORMATION AND USEFUL TIPS

Safety Information

- Disconnect mains plug when :
 - the red light below the TV screen is flashing continuously.
 - a bright white line is displayed across the screen.
 - cleaning the TV screen. Never use abrasive cleaning agents. Use a slight damp chamois leather or soft cloth.
 - there is a lightning storm.
 - the set is left unattended for a prolonged period of time.
- No naked flame sources, such as lighted candles, should be placed on top of the TV or in the vicinity.
- Do not place your TV set under direct sunlight or heat.
- Leave at least 5 cm around each side of TV set to allow for proper ventilation.
- Avoid placing your set (e.g. near the window) where it is likely to be exposed to rain or water.
- No objects filled with liquids should be placed on top the TV so as to avoid dripping or splashing of liquids on the set.

Useful Tips

- Do not leave your set on standby mode for a prolonged period of time. Switch off set to allow it to be demagnetised. A demagnetised set supports good picture quality.
- Do not shift or move the set around when it is switched on. Unevenness in colour in some parts of the screen may occur.
- Never attempt to repair a defective TV yourself. Always consult a skilled service personnel.



BEFORE CALLING SERVICE

Below is a list of frequently occurred symptoms. Before you call for service, make these simple checks. Some of these symptoms can easily be rectified if you know what to do.

Symptom

What you should do

Colour patch
(unevenness)

- Switch off the TV by the mains power button. Wait for 20 minutes before switching on again.
- Check the TV is not placed too near speakers or magnetic objects.

No power

- Check the TV's AC power cord is plugged into the mains socket. If there is still no power, disconnect plug. Wait for 60 seconds and re-insert plug. Switch on the TV again.

No picture

- Check the antenna connection at the rear of the TV.
- Possible TV station problem. Try another channel.

Good picture
but no sound

- Try increasing the volume.
- Check that the sound is not muted. If it is muted, press the **Mute** button on the remote control to restore sound.

Good sound but poor
colour or no picture

- Try increasing the contrast and brightness setting.

Snowish picture and
noise

- Check antenna connection at the rear of the TV.

Horizontal dotted lines

- Possible electrical interference e.g. hairdryer, vacuum cleaner, etc. Switch off appliances.

Double images or
"Ghost" images

- Possible poor positioning of antenna. Using a highly directional antenna may improve reception.

TV not responding to
remote control handset

- Check life span of batteries of remote control handset.
- Aim remote control handset directly at remote control sensor lens on the TV.

HOOKING UP YOUR TV (BASIC CONNECTION)

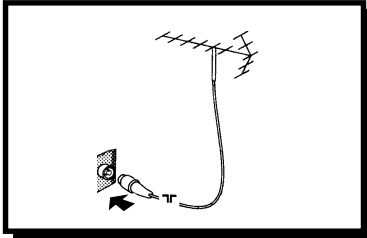

Antenna Connection

- Connect the aerial plug to the antenna socket **T** on the backcover.
- Insert the mains plug into the wall socket.

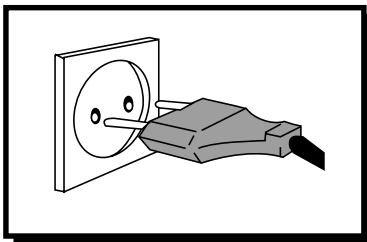

Mains Connection

- For correct mains voltage, refer to type sticker at the rear of the TV set
- Consult your dealer if mains supply is different.
Note :This diagram is not representative of the actual plug and socket.

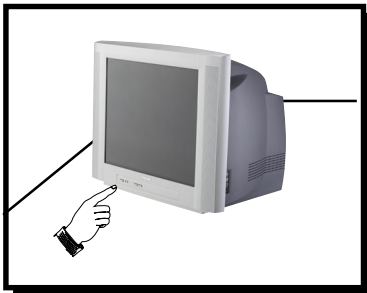

Switching on the Set

- Press the main power button to switch on/ off the TV.
- If the set is on standby (indicator is red), press the **Power** button on the remote control to switch on set.

USE/CARE OF REMOTE CONTROL

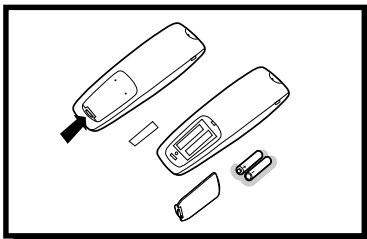

- Insert the correct type of batteries into the compartment.
- Ensure the batteries are placed in the right direction.

CONNECTING THE AUDIO/VIDEO SOCKETS (PLAYBACK)

for 29PT2252

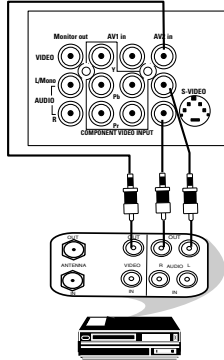

AV sockets on the rear of TV

Back of VCR

VCR (equipped with Video and Audio output sockets)

for 25PT2252

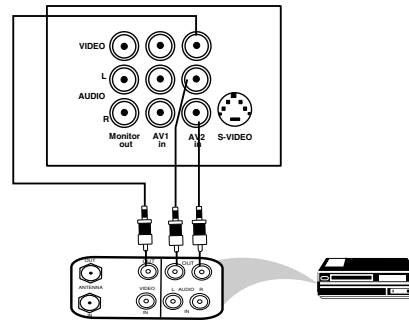

You can view the playback of VCR tapes (Video Disc players, camcorders, etc.) by using the AUDIO and VIDEO INPUT sockets on the rear of the TV.

- Connect the **VIDEO** and **AUDIO IN** sockets on the rear of the TV to the **AUDIO** and **VIDEO OUT** sockets on the VCR.

for 29PT2252

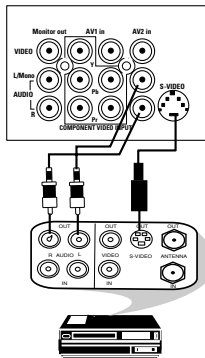

AV sockets on the rear of TV

Back of S-VHS VCR

for 25PT2252

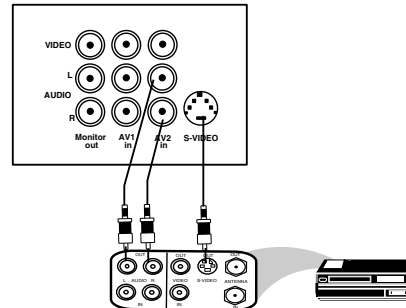

The S-Video connection on the rear of the TV is used for the playback of S-VHS VCR tapes, Video Discs, Video Games or Compact Disc-Interactive (cd-i) discs. Better picture detail and clarity is possible with the S-Video playback as compared to the picture from a normal antenna (RF) connection.

- Connect the **S-VIDEO** socket on the rear of the TV to the **S-VHS OUT** socket on a S-VHS VCR.
- Connect the **AUDIO IN** sockets from the rear of the TV to the **AUDIO OUT** sockets on the VCR. **Note** : You need not connect the **VIDEO IN** socket of the TV if **S-VIDEO IN** socket is connected.



CONNECTING THE AUDIO/VIDEO SOCKETS (PLACKBACK)

for 25PT2252 only

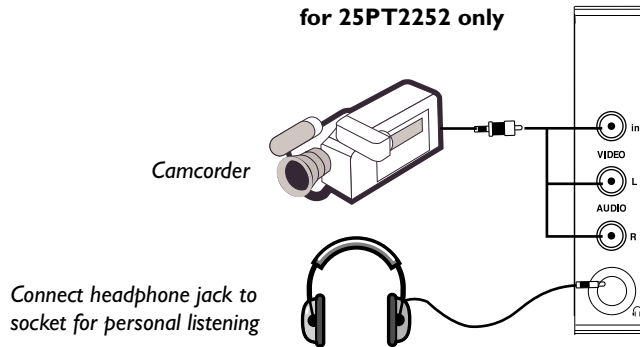

For more convenient direct playback connections, the Side Audio/Video Input sockets allow for quick and easy connections, particularly Camcorder tape recordings.

- Connect the **VIDEO** socket from the Camcorder to the Side **VIDEO in** socket of the TV.
- Connect the **AUDIO OUT** sockets (Right and Left) from the Camcorder to the Side **AUDIO IN** sockets.

for 29PT2252 only

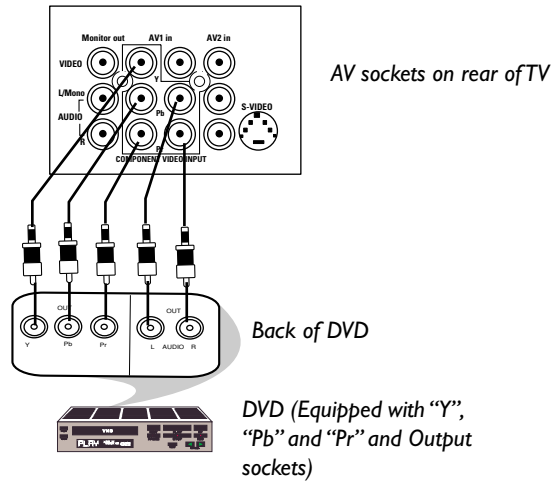

You can view the playback of DVD discs by using the **COMPONENT VIDEO INPUT** sockets on the rear of the TV.

- Connect the **"Y"**, **"Pb"** and the **"Pr"** **INPUT** sockets on the TV to the **"Y"**, **"Pb"** and **"Pr"** **OUTPUT** sockets on the DVD to view playback of DVD discs.





CONNECTING THE AUDIO/VIDEO SOCKETS (RECORDING)

Connection for recording from the TV channel

for 29PT2252

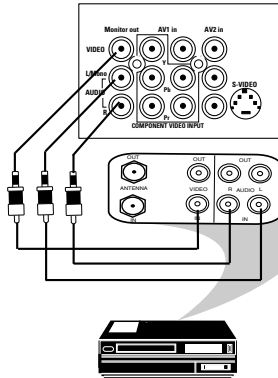

AV sockets on the rear of TV

for 25PT2252

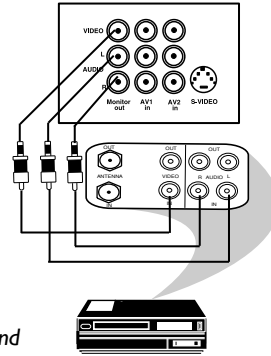

VCR (equipped with Video and Audio input sockets)

- Connect the corresponding **INPUT** sockets of the VCR to the **MONITOR OUTPUT** sockets on the rear of the TV.
- To enhance the sound of your TV, connect the **AUDIO L** and **R** sockets to an external audio system instead of the VCR. For mono equipment, connect only the **AUDIO L** socket.

Connection for recording from one VCR to another VCR

for 29PT2252

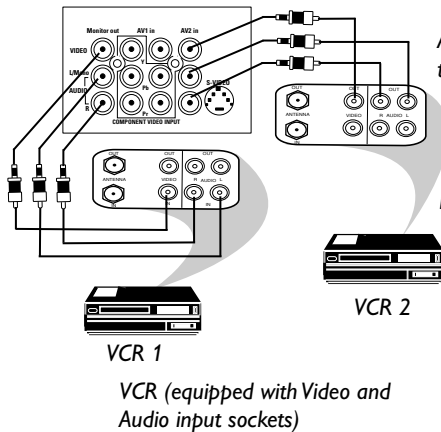

AV sockets on the rear of TV

Back of VCR

for 25PT2252

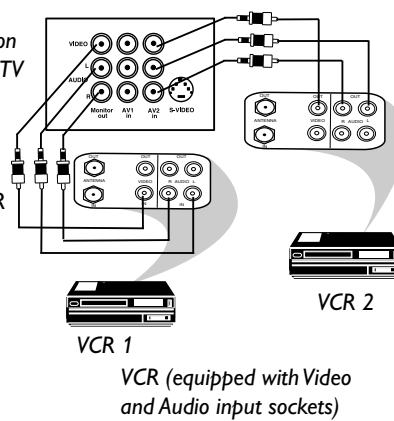

VCR (equipped with Video and Audio input sockets)

- Connect the sockets of the VCR which you wish to record from, to the corresponding sockets at either **AV1** or **AV2**
- Connect the sockets of the receiving VCR to the **MONITOR OUTPUT** sockets on the rear of the TV.





FUNCTIONS OF REMOTE CONTROL

1 Power button

- Switch set off temporarily to standby mode. (The red light indicator lights up when the set is on standby mode).
- To switch on set from standby mode, press Channel +/- , Digit (0 -9) or Power button.

2 Teletext Colour/Personal Zapping buttons

- In teletext mode, the colour buttons allow you to access directly an item or corresponding pages.
- As Personal Zapping buttons, you can surf up to 10 personal channels for each button. For detailed description of functions, refer to section on “Personal Zapping”.

3 Teletext buttons

Allows you to access teletext information. For detailed description of functions, refer to section on “Using the Teletext”

4 Smiley button

Allows to add and store your personal preference channels in your Personal Preference list. For detailed description of functions, refer to section on “Using your Personal Zapping feature”.

5 Timer Button

Allows you to set the clock to switch to another channel at a specified time while you are watching another channel or when the set is on standby mode.

6 Smart Sound Button

Press the Smart Sound button repeatedly to access 4 different types of sound settings and choose your desired setting.

7 Menu Button

Displays the main menu. Also exits menu from screen.

8 Cursor Up Button

Allows you to select the next item on the menu.

9 Cursor Left Button

Allows you to select the sub-menus and adjust the settings.

10 Volume + / – Button

Increases or decreases volume.

11 II

Allows you to switch from Stereo to Mono sound during stereo transmission or to choose between language I or language II during dual sound transmission.

12 A/CH(Alternate channel) Button

Allows you to change between the current channel and the previous channel.

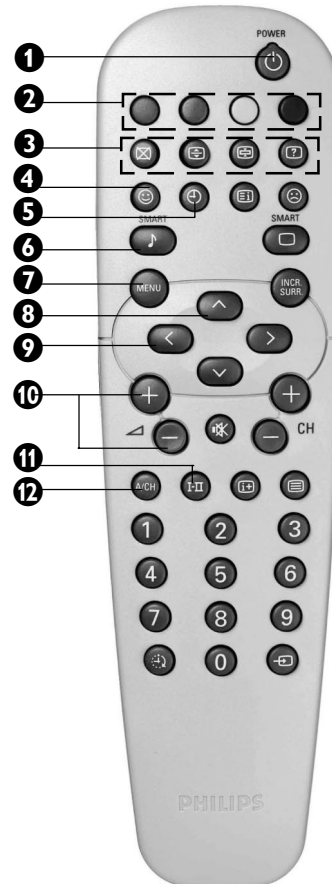



FUNCTIONS OF REMOTE CONTROL



- 13 Main Index Button**
In teletext mode, press button to return to the main index page.
- 14 Frownie button**
Allows to delete stored personal preference channels in your Personal Preference list. For detailed description of functions, refer to section on “Personal Zapping”.
- 15 Smart Picture Button**
Press the Smart Picture button repeatedly to access 5 different types of picture settings and choose your desired setting.
- 16 Incredible Surround Button**
 - Allows you to select Incredible Surround sound when transmission is in stereo mode.
 - Allows you to select Spatial Sound when transmission is in mono mode.
- 17 Cursor Right Button**
Allows you to access the sub-menus and adjust the settings.
- 18 Cursor Down Button**
Allows you to select the next item on the menu.
- 19 Channel + / – Buttons**
Allows you to select channels in ascending or descending order.
- 20 Mute Button**
Mutes sound. To restore sound, press button again.
- 21 Teletext Button**
Refer to section on “Using the Teletext”
- 22 OSD button**
Allows you to display the current channel number. It also allows to exit menu from the screen after control adjustments.
- 23 Digit (0 -9) Buttons**
Press to select a channel. For a 2-digit channel number, press the first digit and followed immediately by the second digit.
- 24 A/V Button**
Allows you to select the AV channels.
- 25 Sleeptimer Button**
Allows you to select a time period after which the set will switch to standby mode automatically.



FUNCTIONS OF TV CONTROLS

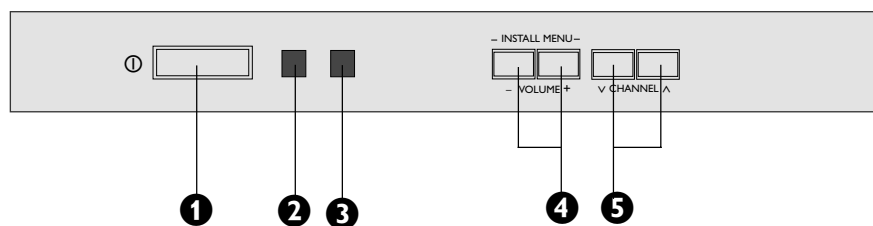

1	Mains Power button	Switch mains power on or off.
2	Standby light indicator	Indicate red light when standby mode is activated.
3	Remote Sensor	Acts as a sensor for activating the controls of the TV when remote control handset is aimed at it.
4	Volume + / - buttons	Adjust sound volume softer/louder.
5	Channel ∇ / ▲ buttons	Select channel in descending/ascending order.

Note







- You can enter the main menu by pressing both the Volume - and + buttons at the same time.
- Press the Channel ∇ or ▲ button to select the next item on the menu.
- Press Volume - or + button to access sub-menu and adjust the settings.

SELECTING THE MENU LANGUAGE

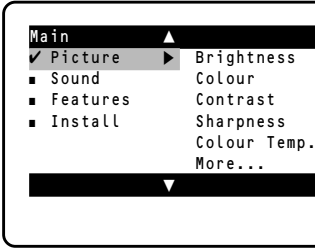
Operating instructions generally explains the operation of the TV set using the buttons on the remote control unless otherwise stated. Please read the following instructions carefully and follow the steps as shown to familiarise yourself with the installations and all features available in your set.

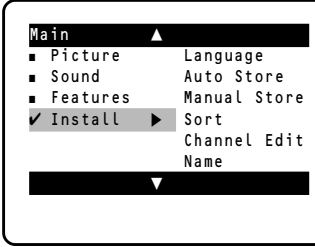
Note: When there is no signal input to the TV, you may encounter instability of the on screen display. In this instance, please use the  button on your remote control to select an AV channel.

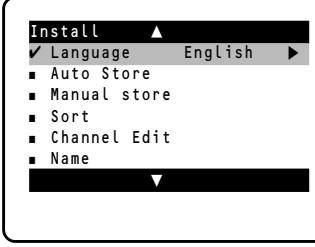







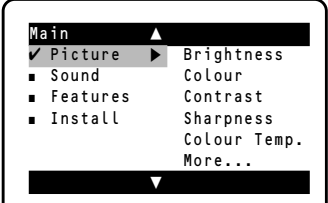

The **Language** feature allows you to set the TV's on-screen menu to be shown in your desired language.

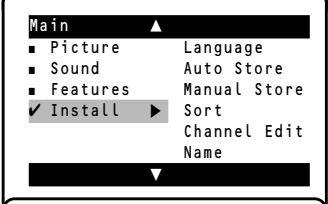
Step	Press button		Result on screen
1		Enter main menu.	
2		Select Install .	
3		Enter the Install menu.	
4		Press button repeatedly to cycle through the language list and select the language of your choice.	
5		Exit menu from screen.	



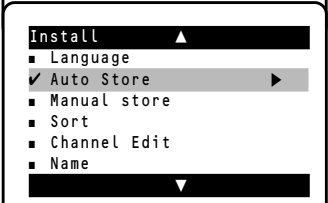



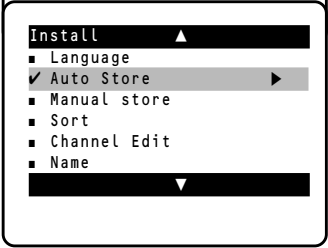



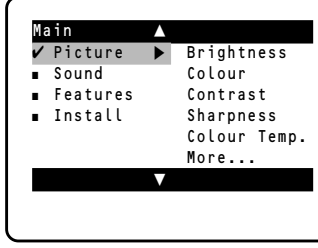

AUTOMATIC TUNING AUTOMATIC TUNING OF CHANNELS

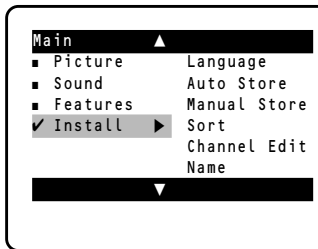
Automatic tuning of channels allows you to store each programme automatically.

Step	Press button	Result on screen
1	 Enter main menu.	
2	 Press button repeatedly until Install is selected.	
3	 Enter install menu.	
4	 Select Auto Store .	
5	 Start automatic tuning of channels.	
6	 When tuning is completed, exit menu from screen.	

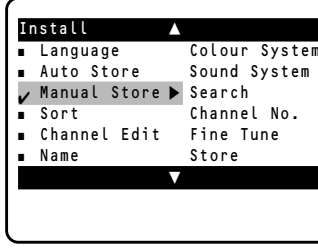
MANUAL TUNING OF CHANNELS

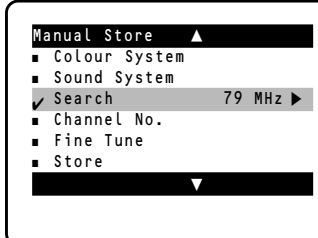
Manual tuning of channels allows you to select your preferred channel number for every available programme.

Step	Press button		Result on screen
1		Enter main menu.	
2		Press button repeatedly until Install is selected.	
3		Enter install menu.	
4		Press button repeatedly until Manual Store is selected.	
5		Enter manual store menu.	
6		Press button repeatedly until Search is selected.	



MANUAL TUNING OF CHANNELS

Step	Press button		Result on screen
		Start manual searching. Searching stops once a transmitting signal is found.	
		Select Channel .	
	 1 2 3 4 5 6 7 8 9 0	Key in the channel number.	
		Press button repeatedly until Store is selected.	
		Store tuned channel. Note : If you want to continue searching for another transmitting channel, repeat steps 7 to 11.	
		Exit menu from screen.	





SELECTING THE COLOUR/SOUND SYSTEM



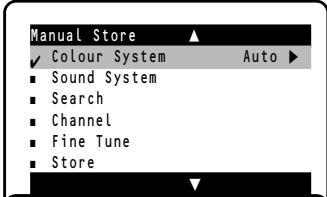
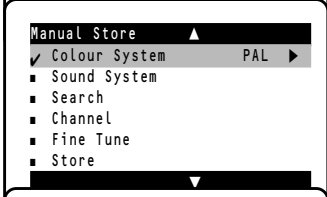
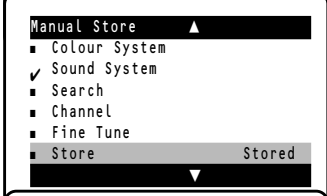
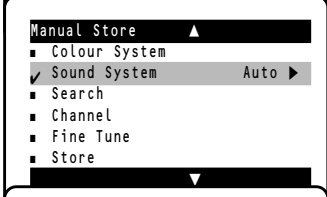
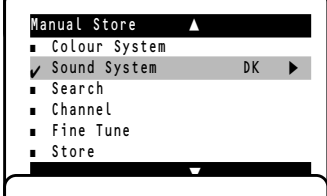
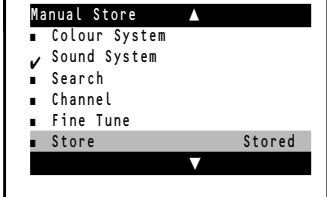







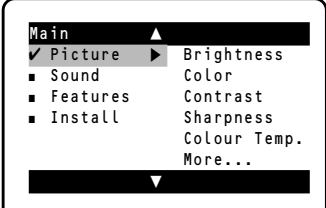

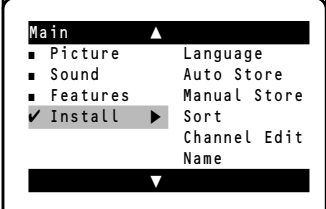

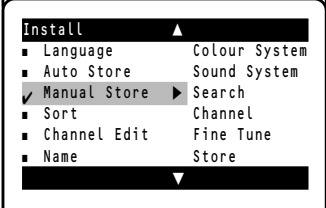

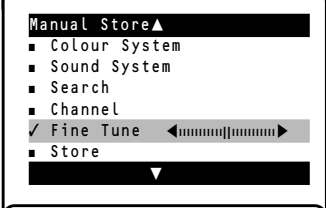
This feature allows you to select your desired **Colour** and **Sound** system. If **Auto** is selected, the respective colour and sound system will be automatically selected according to the transmission system. **Note** : Select your desired colour and sound system manually if reception is poor at **Auto** mode.

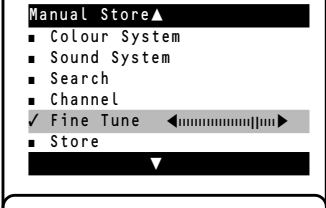
	Step	Press button		Result on screen
	Repeat step 1 to step 5 as in "Manual Tuning of TV Channels"			
			Colour System is selected.	
6	<	or >	Select the desired colour system (Auto, PAL, NTSC 3.58, NTSC 4.43 or SECAM).	
7	v		Press button repeatedly until STORE is selected.	
8	>		Store selected system.	
9	v or ^		Proceed to select Sound System .	
10	<	or >	Select the desired sound system (Auto, BG, I, DK or M).	
11	v		Press button repeatedly until STORE is selected.	
12	>		Store selected system.	
13	+		Exit menu from screen.	

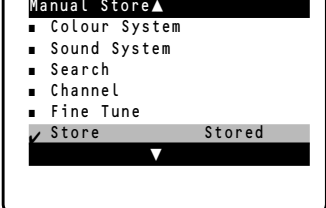

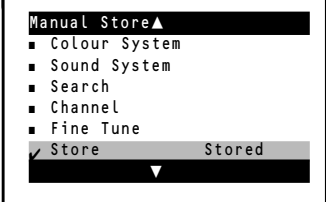
FINE TUNING OF CHANNELS

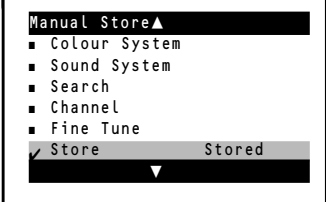
This feature allows you to adjust picture reception in areas of weak reception.

Step	Press button	Result on screen
1	 Enter main menu.	
2	 Press button repeatedly until Install is selected.	
3	 Enter install menu.	
4	 Press button repeatedly until Manual Store is selected.	
6	 Press button repeatedly until Fine Tune is selected.	
7	 or  Fine tune until the best reception is obtained.	
8	 Select Store .	
9	 Store last fine-tuned status.	
10	 Exit menu from screen.	



SORTING OF CHANNELS

This feature rearranges channel numbers.

- | Step | Press button | |
|-----------|--------------|---|
| 1 | | Enter main menu. |
| 2 | | Press button repeatedly until Install is selected. |
| 3 | | Enter install menu. |
| 4 | | Press button repeatedly until Sort is selected. |
| 5 | | Enter sort mode. |
| 6 |
or
 | Select the channel number you want to change from (e.g. 002). |
| 7 |
or
 | Confirm selection. |
| 8 | | Select the channel number you want to change to (e.g. 005). |
| 9 | | Confirm selection.
The change is done.
Note : Channel numbers 5, 4 and 3 will move upwards accordingly. that is, Channel 5 will move up to Channel 4, Channel 4 to 3 and Channel 3 to 2. |
| 10 | | Exit menu from screen. |

Result on screen

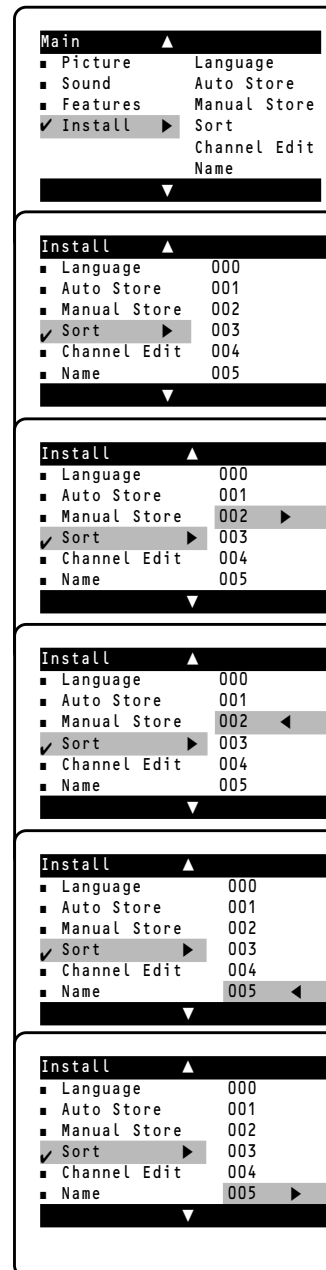



EDITING OF CHANNELS

This feature allows you to skip or edit channels which have bad or weak TV signal or channels that you do not watch often. **Note** : Once a channel is skipped, you cannot have access to it by the CH (Channel) + or – button. You can only have access to the channel by the Digit (0 -9) buttons.

Step	Press button	Result on screen
1	Enter main menu.	
2	Press button repeatedly until Install is selected.	
3	Enter install menu.	
4	Press button repeatedly until Channel Edit is selected.	
5	Enter Channel Edit menu.	
6	Key in the channel number to be skipped.	
7	Select Skipped .	
8	Select On to skip channel.	
9	Exit menu from screen.	

HOW TO RESTORE SKIPPED CHANNELS

- Repeat **Steps 1 to 5** as in "Editing of Channels".
- Key in the channel number to be restored by the **Digit (0 - 9)** button.
- Select **Skipped** by the button.
- Select **Off** to restore channel by the button.
- Exit menu from screen by the button.

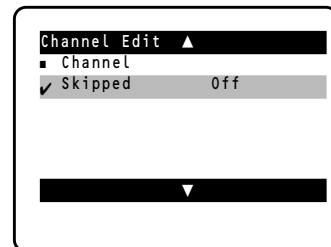



NAMING OF CHANNELS

This feature enables you to name or rename channels.

Step	Press button	Result on screen
1	Enter main menu.	
2	Press button repeatedly until Install is selected.	
3	Enter install menu.	
4	Press button repeatedly until Name is selected.	
5	Enter name mode.	
6	or Select the channel you want to name.	
7	Move to first character slot.	
8	or A cursor appears for you to start the input of characters. Select the character you want. Move to next character slot by the button and select the next character. You can enter up to a maximum of 5 characters. After naming the channel, press button repeatedly until name appears on the top left hand corner of the screen. This will ensure that the name is stored in the memory.	
9	Exit menu from screen.	



ADJUSTING THE TV PICTURE

The picture menu allows you to make adjustments to the picture.

Step	Press button	Result on screen
1	Display the main menu on screen.	
2	Enter Picture menu.	
3	or Select item.	
4	or Adjust level or select desired setting.	
5	Exit menu from screen.	

Picture menu items	Activities
Brightness	Increase or decrease brightness level.
Colour	Increase or decrease color level.
Contrast	Increase or decrease contrast level.
Sharpness	Increase or decrease sharpness level to improve detail in picture.
Colour temperature	Choose from 3 settings (Normal, Warm or Cool).
NR (Noise Reduction)	Select "On" to reduce "noisy" picture (little dots on picture) due to weak signal.
Contrast +	Select "On" to allow you to optimise the total contrast for improved picture quality.



ADJUSTING THE TV SOUND

The sound menu allows you to make adjustments to the sound.









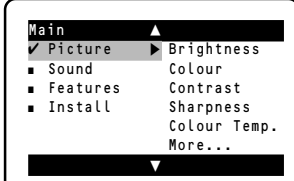

Step	Press button	Result on screen
1	Display the main menu on screen.	
2	Select Sound menu.	
3	Enter Sound menu.	
4	or Select item.	
5	or Adjust level or select desired setting.	
6	Exit menu from screen.	

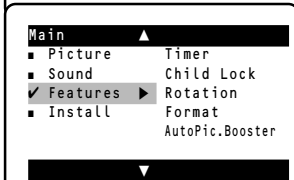
Sound menu items	Activities
Treble	Increase or decrease high frequency level.
Bass	Increase or decrease low frequency level.
Balance	Increase or decrease to adjust balance level.
AVL (Auto Volume Leveller)	Select On to enable volume to remain at a pre-determined level should there be a sudden change in volume during commercial breaks or channel switching.
Incredible Surround	Select On to boost the effect of stereo sound.
Ultra Bass	Select On to enjoy enhanced bass output.

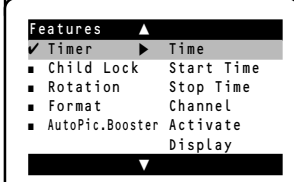
USING THE TIMER

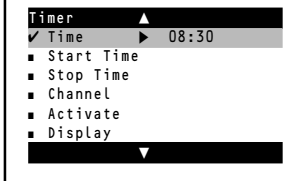
The Timer feature allows you to set the timer to switch to another channel at a specified time while you are watching another channel or when the TV is on standby mode.

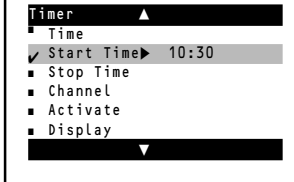
Note : For the timer to function, the set must not be switched off. Once the set is switched off, the timer is disabled.

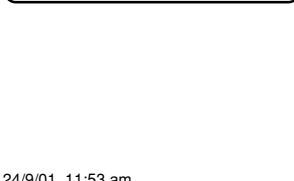
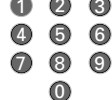
Step	Press button		Result on screen
1		Display the main menu on screen.	
2		Select Features .	
3		Enter the Features menu.	
4		Enter Timer menu.	
5		Key in the current time starting from the hour follow by minute. This is the time where the "start time" and "stop time" will take reference from.	
6		Select Start Time .	
7		Key in the time you want the programme to be switched on.	



USING THE TIMER

Step	Press button		Result on screen
8		Select Stop Time .	
9		Key in the time you want the programme to be switched off.	
10		Select Channel .	
11		Key in the channel you want to switch to.	
12		Select Activate .	
13		Activate timer. You can select Once, Daily or Off .	
14		Select Display .	
15		Select On mode if you want to display the time on the TV screen.	
16		Exit menu from screen.	

Note :

- After the Stop Time is activated, the TV will go to standby mode immediately.
- If Stop Time is not keyed in, the set will go to standby mode after 2 hours.
- To switch on set from standby mode, press **Channel +/-**, **Digit (0 -9)** or **Power** button.

ACTIVATING THE CHILD LOCK (ACCESS CODE)

The Child Lock feature allows you to lock channels to prevent your children from watching programmes you deem undesirable.

Note : You can only have access to the locked channels via the remote control. Keep the remote control out of reach so as to prevent your children from having access to it.





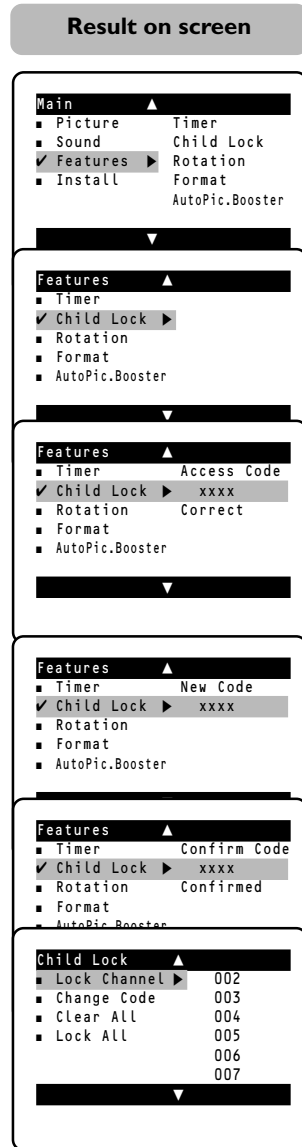



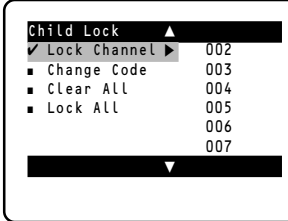

Step	Press button	Result on screen
1	MENU	Display the main menu on screen.
2	↓	Press button repeatedly until Features is selected.
3	→	Enter the Features menu.
4	↓	Select Child Lock .
5	→	Enter Child Lock mode.
6	1 2 3 4 5 6 7 8 9 0	Key in the 4-digit access code. For the first time or if you have forgotten the access code, enter the universal access code 0711 twice. It will now prompt you to key in a New Code .
7	1 2 3 4 5 6 7 8 9 0	Key in your preferred code (4-digit).
8	1 2 3 4 5 6 7 8 9 0	Key in the new code the second time to confirm code.
9	EXIT	The Child Lock menu will now appear. You can proceed to lock channel (refer to section on "Lock Channel"). If not, exit menu from screen.

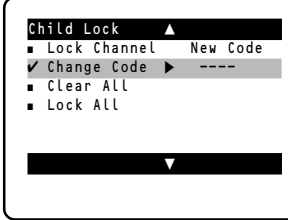
Note : After you have exit menu from screen and you want to enter the child lock menu again, you need to key the new access code only once.

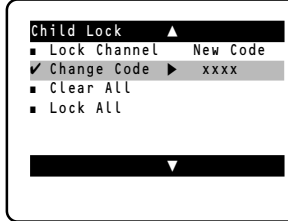

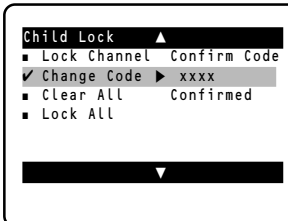
ACTIVATING THE CHILD LOCK (CHANGE CODE)

Note : You need to key the access code only once.

Step	Press button		Result on screen
Repeat Steps 1 to 8 as in " ACTIVATING THE CHILD LOCK (ACCESS CODE) "		The Child Lock menu will now appear. You can proceed to change code.	
9		Select Change Code .	
10		Enter change code mode.	
11		Key in your preferred code (4-digit).	
12		Key in the new code the second time to confirm code.	
13		Exit menu from screen.	

ACTIVATING THE CHILD LOCK (LOCK CHANNEL)

Step	Press button		Result on screen
Repeat Steps 1 to 8 as in " CHILD Lock (ACCESS CODE) "		The Child Lock menu will now appear. You can proceed to lock channel.	
9		Enter lock channel mode.	
10	 or 	Select the channel you want to lock.	
11		Activate blocking of channel. A keylock symbol will appear beside the channel number indicating that it is locked. Note :To lock more than one channel, repeat Steps 10 to 11 before exiting menu from screen.	
12		Exit menu from screen.	



ACTIVATING THE CHILD LOCK (LOCK ALL)

You can choose to lock all channels in the **Lock All** mode in the Child Lock menu.

Step **Press button**

Repeat **Steps 1 to 8** as in "**CHILD Lock (ACCESS CODE)**"

The Child Lock menu will now appear. You can proceed to lock all channels.

Result on screen

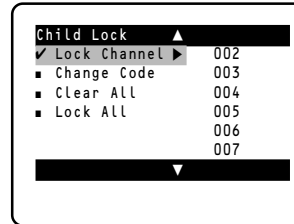

9



Select **Lock All**.

10



Select the **On** option to lock all channels.

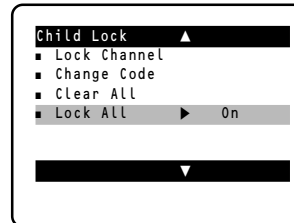

11



Exit menu from screen.

ACTIVATING THE CHILD LOCK (CLEAR ALL)

To unlock channels that you have locked, enter the Child Lock menu and select the **Off** option **Clear All** mode.

Step **Press button**

Repeat **Steps 1 to 8** as in "**CHILD Lock (ACCESS CODE)**"

The Child Lock menu will now appear. You can proceed to clear all channels.

Result on screen

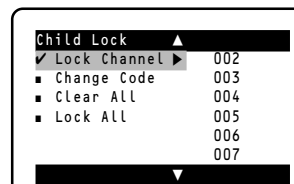

9



Select **Clear All**.

10



Select the **Off** option to unlock all channels.

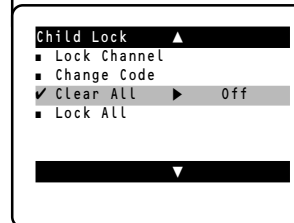

11



Exit menu from screen.



USING THE SCREEN FORMAT

You can have a choice of two formats for your viewing pleasure, namely :- **4:3** mode and the **EXPAND 4:3** mode through the **FORMAT** menu.

Step	Press button	Result on screen
1		Display the main menu on screen.
2		Press button repeatedly until Features is selected.
3		Enter the Features menu.
4		Press button repeatedly until Format is selected.
5		Press the button repeatedly to cycle through the different formats (4:3 or Expand 4:3) or and select your desired format.
6		Exit menu from screen.

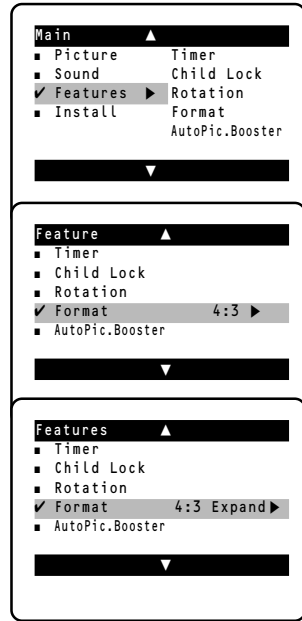

When to use the Screen Formats

4:3 format

Select the 4:3 format if you want to display the 4:3 picture using the full surface of the screen.

Expand 4:3 format

Select the Expand 4:3 format if you want to expand movie images recorded in the letterbox format. When this format is selected, the black horizontal bars at the top and bottom are expanded thus filling up the entire TV screen.

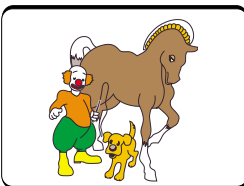
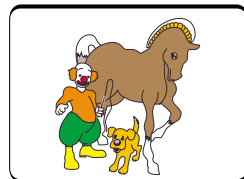
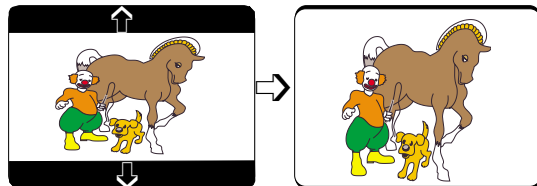



SMART PICTURE CONTROL

Whether you are watching a movie or video game, your TV has automatic video control settings matched to your current program source or content. The Smart Picture feature quickly resets your TV's video controls of program for a number of different types of programs and viewing conditions you may have in your home. Each Smart Picture setting is preset at the factory to automatically adjust the TV's Brightness, Colour, Picture and Sharpness levels.

Step

Press button

1



Press button repeatedly to cycle through the 5 settings namely, **Personal**, **DVD/VCD**, **Rich**, **Natural** and **Soft** and select your desired picture setting.

2



Exit menu from screen.

Defintion of Picture Settings

Personal : Picture settings are set to your preference.

DVD/VCD : For optimal picture setting, whenever the source is connected to DVD/VCD player, select DVD/VCD setting for AV mode.

Rich : Emphasize very vibrant colours. This setting is the optimal setting when you are viewing TV programmes in a brightly-lit room.

Natural : Emphasize original colours.

Soft : Emphasize "warm" colours. (Suitable for dimly-lit room condition and gives cinema-like effect when light is switched off).

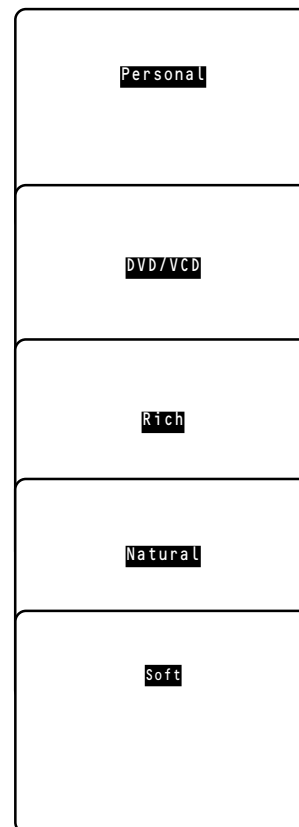



SMART SOUND CONTROL

Whether you are watching a movie or video game, your TV has automatic sound control settings matched to your current program source or content. The Smart Sound feature quickly resets your TV's sound controls of program for a number of different types of programs and viewing conditions you may have in your home. Each Smart Sound setting is preset at the factory to automatically adjust the TV's Treble and Bass levels.

Step

Press button

1



Press button repeatedly to cycle through the 4 settings namely, **Personal**, **Theatre**, **Music** and **Voice** and select your desired sound setting.

2



Exit menu from screen.

Definition of Sound Settings

Personal : Sound settings are set to your preference.

Theatre : Emphasize sensation to action.
(Bass and Treble boosted)

Music : Emphasize low tone (Bass boosted).

Voice : Emphasize high tone (treble boosted).

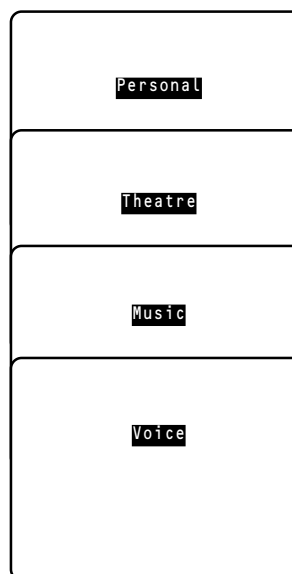



PERSONAL ZAPPING

A list or series of favourite TV programs can be selected and stored in the 4 coloured buttons with the Personal Zapping feature. With this feature you can easily view up to a total of 10 preferred channels for each coloured button.

Adding Channels to the Favourite list

Step	Press button		Result on screen
1		Select a channel by the Digit buttons	
2		Press button to display list.	
3		Choose your favourite colour button to store selected channel. Repeat steps 1 to 3 to add and store your favourite channels to the list.	
4		Exit menu from screen.	

To view through the favourite list

1		Press the colour button that you have selected.
2		Press button repeatedly to cycle through your favourite list and view your favourite channel.

Deleting Channels from the Favourite list

1		Select a colour button and press button repeatedly to select the channel you want to delete.	
2		Press button to display list.	
3		Press button to remove item. Repeat steps 1 to 3 to delete more channels from list.	
4		Exit menu from screen.	



AUTOMATIC PICTURE BOOSTER

If the transmission signal is weak, the Automatic Picture Booster built into the TV set will increase the signal level to provide a good picture at all time. You have a choice to turn on/off the feature, depending on the signal conditions locally.

Step	Press button		Result on screen
1		Display the main menu on screen.	
2		Select Features .	
3		Enter the Features menu.	
4		Select Auto Pic. Booster .	
5		Select On .	
6		Exit menu from screen.	



ROTATION

Note: Applicable to certain models only.

Due to the earth's magnetic field and position of the TV, there may be a slight tilting of the picture to the left or right when the set is switched on. When this phenomena occurs, select **Rotation** in the **Features** menu and adjust accordingly.

Step	Press button		Result on screen
1		Display the main menu on screen.	
2		Select Features .	
3		Enter the Features menu.	
4		Select Rotation .	
5	 or 	Press repeatedly until you deem picture is in the normal position.	
6		Exit menu from screen.	



USING THE TELETEXT

If a TV channel broadcast contains teletext information, each channel that broadcasts teletext transmits a page (index page) with information on how to use the teletext system, usually on page 100. The system transmitted is indicated in the option line at the bottom of the screen.

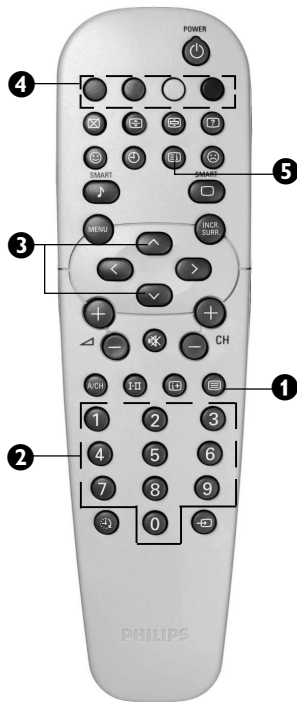

Press button

Result on screen

- 1 On/Off teletext and Superimpose teletext page over TV programme**

Press the button once to switch on teletext display. (A channel in which teletext is being transmitted must be selected). Press the button the second time superimpose the teletext page over the TV programme. Press the button the third time to exit teletext mode.



- 2 Selecting a teletext page**



Key in the required teletext page (3 digits). The page number is displayed at the top left hand corner of the screen. When the teletext page is located, the counter stops searching. If the counter keeps searching, it means that the page is not available for selection. If you make a mistake in keying the page number, you have to complete keying the 3-digit number before re-keying the correct page number.

- 3 Accessing a teletext page**



Press the button to display the next page and the button to display the previous page.

- 4 Direct Access to an item or corresponding pages**



The 4-colour buttons allow you to access directly an item or corresponding pages.

- 5 Main Index**



Press the button to return to the main index page.





USING THE TELETEXT



Press button

Result on screen

6 Interrupt



Press the button to change to TV mode. Press the button again to return to teletext mode and to the teletext page.

7 Enlarge



Press the button once to enlarge and view the top half of the page. Press the button the second time to enlarge and view the bottom half of the page. Press the button the third time to return to normal size page.

8 Hold



A selected page sometimes contains a few sub-pages. The sub-page will automatically move to the next sub-page after about 20 seconds. The total number of sub-pages are indicated at the top right hand corner of the screen. Press the button once to hold page and the second time to release holding of page.

9 Reveal/Conceal



Press the button once to reveal hidden information (solutions to puzzles, riddles, etc). Press the button the second time to conceal information. This button is applicable only to teletext page with puzzles, riddles, etc.)



SPECIFICATIONS

	25PT2252	29PT2252
Picture tube screen size	630 mm	705 mm
Picture tube visible area	600 mm	675 mm
Audio Output : Speaker	2 x 5 W	
TV System	NTSC M PAL B/G PAL B/H (only for certain versions) PAL D/K PAL I SECAM B/G SECAM D/K SECAM K1	
Playback System	NTSC 3.58, NTSC 4.43, PAL 60	
Set Dimensions :		
Width	670 mm	778 mm
Depth	520 mm	580 mm
Height	460 mm	532 mm
Net Weight of Set (approximate)	30 kg	45.5 kg

Note

For Operating Voltage, Frequency, Power Consumption and Version Number, refer to the type number at the rear of the set.



3139 125 28722

